



### **Absolute Maximum Ratings ( $T_A=25^\circ\text{C}$ unless otherwise specified)**

Parameter	Symbol	Value	Unit
Peak Pulse Power (8/20 $\mu\text{s}$ )	Ppk	1700	W
Peak Pulse Current (8/20 $\mu\text{s}$ )	Ipp	70	A
ESD per IEC 61000-4-2 (Air)	VESD	$\pm 30$	kV
ESD per IEC 61000-4-2 (Contact)		$\pm 30$	
Operating Temperature Range	TJ	-55 to +125	$^\circ\text{C}$
Storage Temperature Range	Tstg	-55 to +150	$^\circ\text{C}$

### **Electrical Characteristics ( $T_A=25^\circ\text{C}$ unless otherwise specified)**

Parameter	Symbol	Min	Typ	Max	Unit	Test Condition
Reverse Working Voltage	VRWM			12	V	
Breakdown Voltage	VBR	13.3	14.0		V	IT = 1mA
Reverse Leakage Current	IR			1	$\mu\text{A}$	VRWM = 12V
Clamping Voltage	VC		17	19	V	I <sub>PP</sub> = 20A (8 x 20 $\mu\text{s}$ pulse)
Clamping Voltage	VC		24	26	V	I <sub>PP</sub> = 70A (8 x 20 $\mu\text{s}$ pulse)
Junction Capacitance	CJ		380	420	pF	VR = 0V, f = 1MHz

**Typical Performance Characteristics (TA=25°C unless otherwise Specified)**

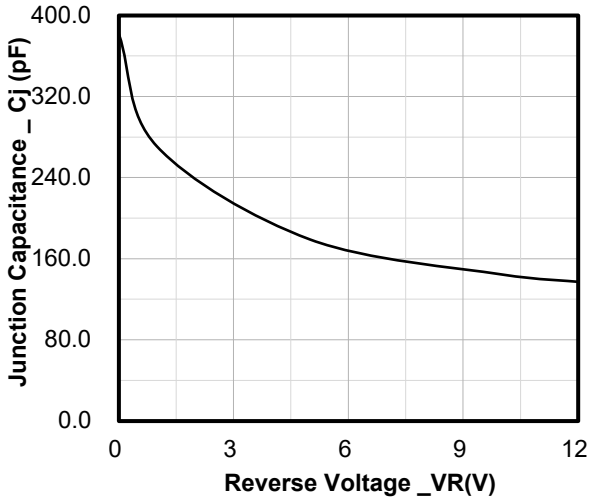

**Junction Capacitance vs. Reverse Voltage**

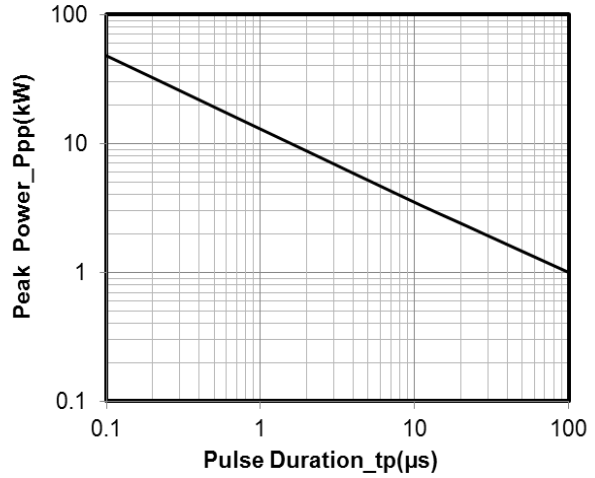

**Peak Pulse Power vs. Pulse Time**

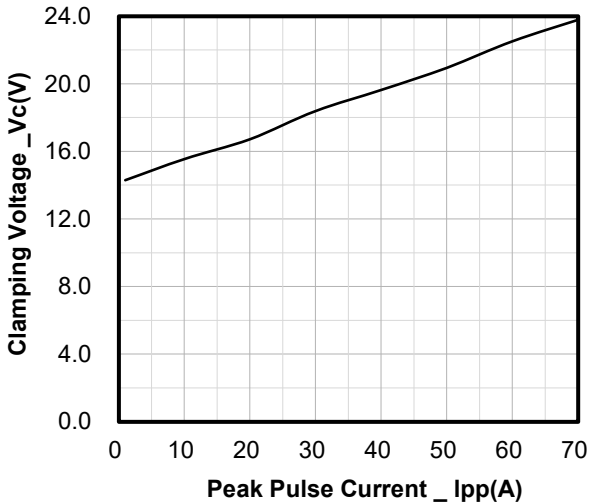

**Clamping Voltage vs. Peak Pulse Current**

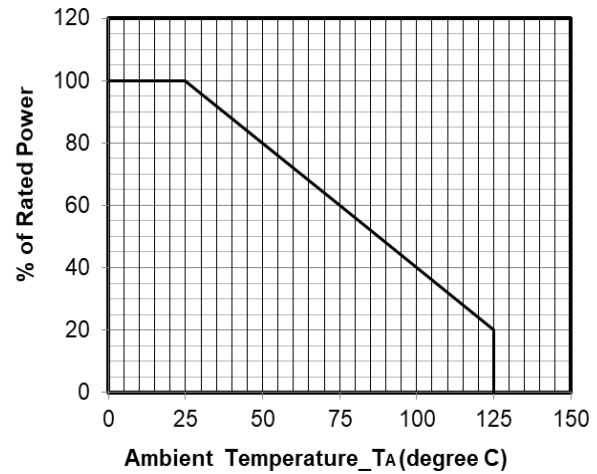

**Power Derating Curve**

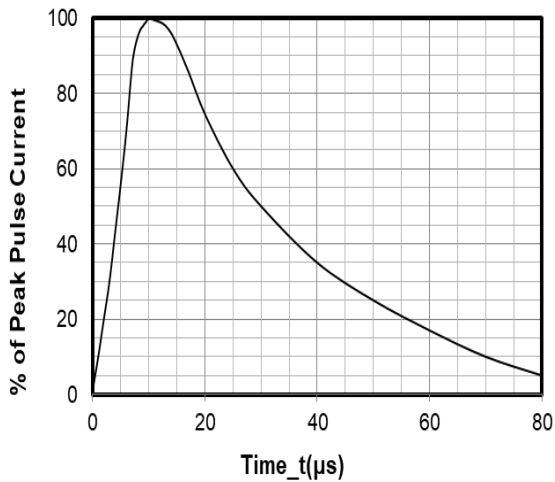

**8 X 20μs Pulse Waveform**

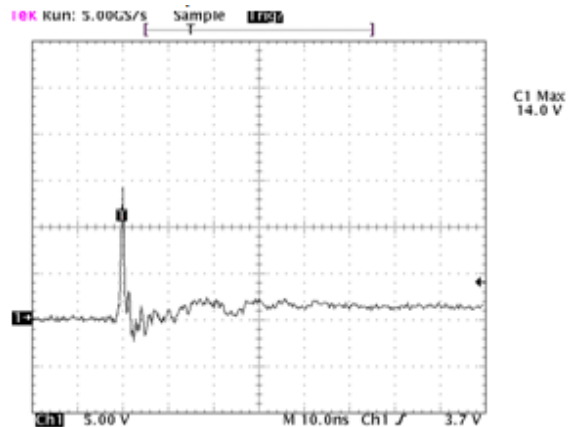

Note: Data is taken with a 10x attenuator

**ESD Clamping Voltage**

**8 kV Contact per IEC61000-4-2**

## DFN1610-2 Package Outline Drawing

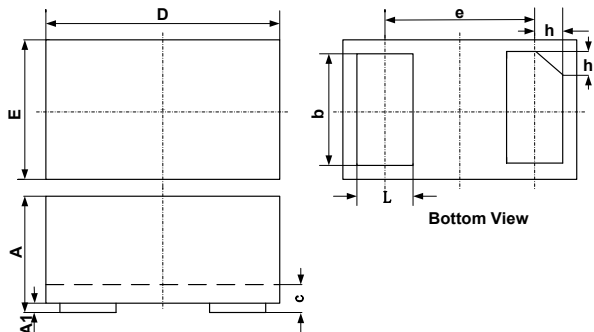

SYM	DIMENSIONS					
	MILLIMETERS			INCHES		
	MIN	NOM	MAX	MIN	NOM	MAX
A	0.45	0.50	0.55	0.018	0.020	0.022
A1	0.00	0.02	0.05	0.000	0.001	0.002
b	0.75	0.80	0.85	0.030	0.032	0.034
c	0.10	0.15	0.20	0.004	0.006	0.008
D	1.55	1.60	1.65	0.062	0.064	0.066
e	1.10 BSC			0.044 BSC		
E	0.95	1.00	1.05	0.038	0.040	0.042
L	0.35	0.40	0.45	0.014	0.016	0.018
h	0.15	0.20	0.25	0.006	0.008	0.010

## Suggested Land Pattern

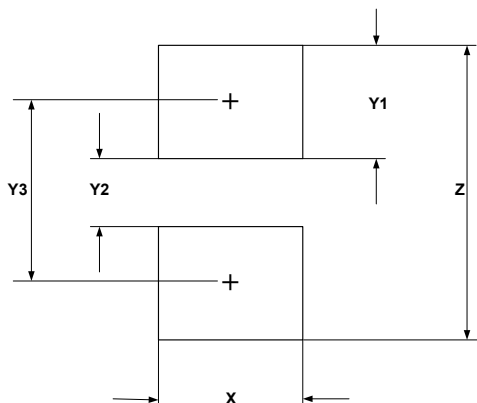

SYM	DIMENSIONS	
	MILLIMETERS	INCHES
X	1.00	0.040
Y1	0.62	0.025
Y2	0.60	0.024
Y3	1.22	0.049
Z	1.85	0.074

## Contact Information

Changzhou D-first Electronics CO.,Ltd.

[www.first-electronic.com](http://www.first-electronic.com)

Email: [xhf@first-electronic.cn](mailto:xhf@first-electronic.cn)

Phone: +86 (0519) 8817 1671